



TECHNICAL DATA

Voltage	nominal	120	kV
	maximum for test	132	
Focal spot ((IEC60336:2005)		0,5	mm
Filament characteristics		3,5 ÷ 6,0	V
		2,5 ÷ 4,0	A
Anode material		Tungsten	
Target angle		10	°
Anode heat storage capacity		40000	J
Maximum anode cooling rate		500	W
Nominal anode input power at 0.1 s (DC)		1900	W
Inherent filtration		0,5 mm Al	
Maximum diameter		45	mm
Overall length		171 max	mm
Weight (without lead shield)		480	g

GENERAL INFORMATIONS

When mounting tube inserts adopt proper caution, in order to avoid glass bulb breaking and fragments projection. Please use protective gloves and glasses.

Tube insert connected to H.V. supply is a radiation source: be sure to take all necessary safety cautions

- Wash thoroughly with alcohol the external surface of tube insert (care of fire risk). Remove any labels on the glass bulb. Avoid contact of dirty surfaces with cleaned tube insert.
- Clamp system inside housing or self-contained units must not mechanically stress the tube.
- After installation, check the right working of the tube (no fluctuation of tube current nor crackling)
- Comply with insert thermal parameters, planning and programming the exposure parameters and cooling pauses. Housing or self-contained units must be provided with an adequate thermic protection.
- Voltages indicated in charts are valid for transformer supplied with ground center.
- Tube inserts contain environment polluting materials, particularly lead liner tubes. Please apply to qualified operator for waste disposal, according to local regulation requirements.

INCIDENT REPORT ACCORDING TO 93/42/EEC MEDICAL DEVICES DIRECTIVE

In order to comply with CE marking requirements, end users have to report to local Competent Authority all the informations about possible incidents involving the device, regarding any deterioration in its characteristics and performances, as well as any inaccuracies in this documentation, which might lead to or might have led to the death of patient / user or a deterioration in his state of health. This information must be promptly reported also to C.E.I. in order to start manufacturer reporting, as per above mentioned directive.



this mark assures device conformity to
EC Directive 93/42 on Medical Devices Safety.



DIMENSIONS

WEIGHT : 480 g

SCALE 2:3

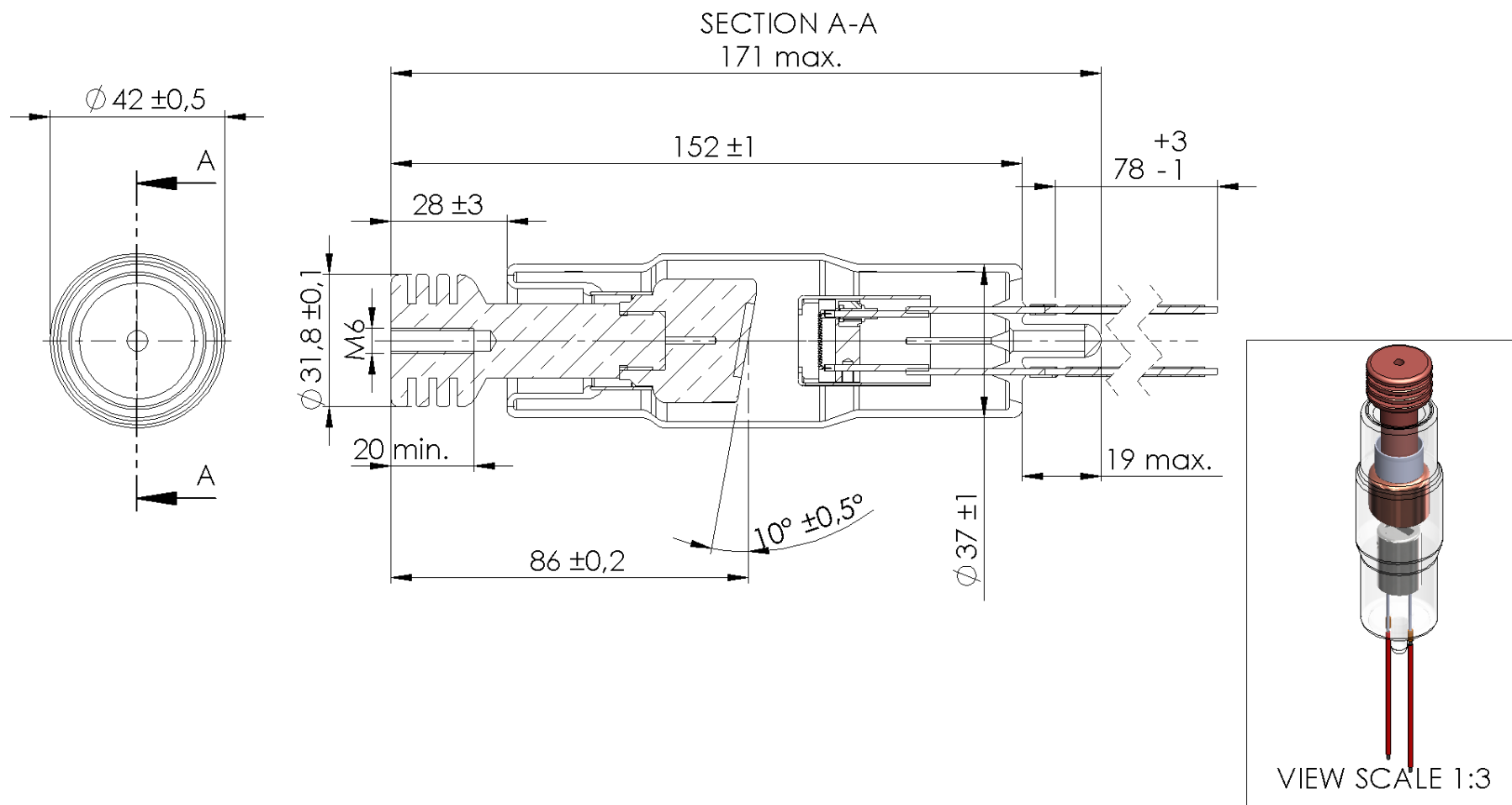



DIMENSIONS WITH LEAD SHIELD

WEIGHT: 1160 g

SCALE 2:3

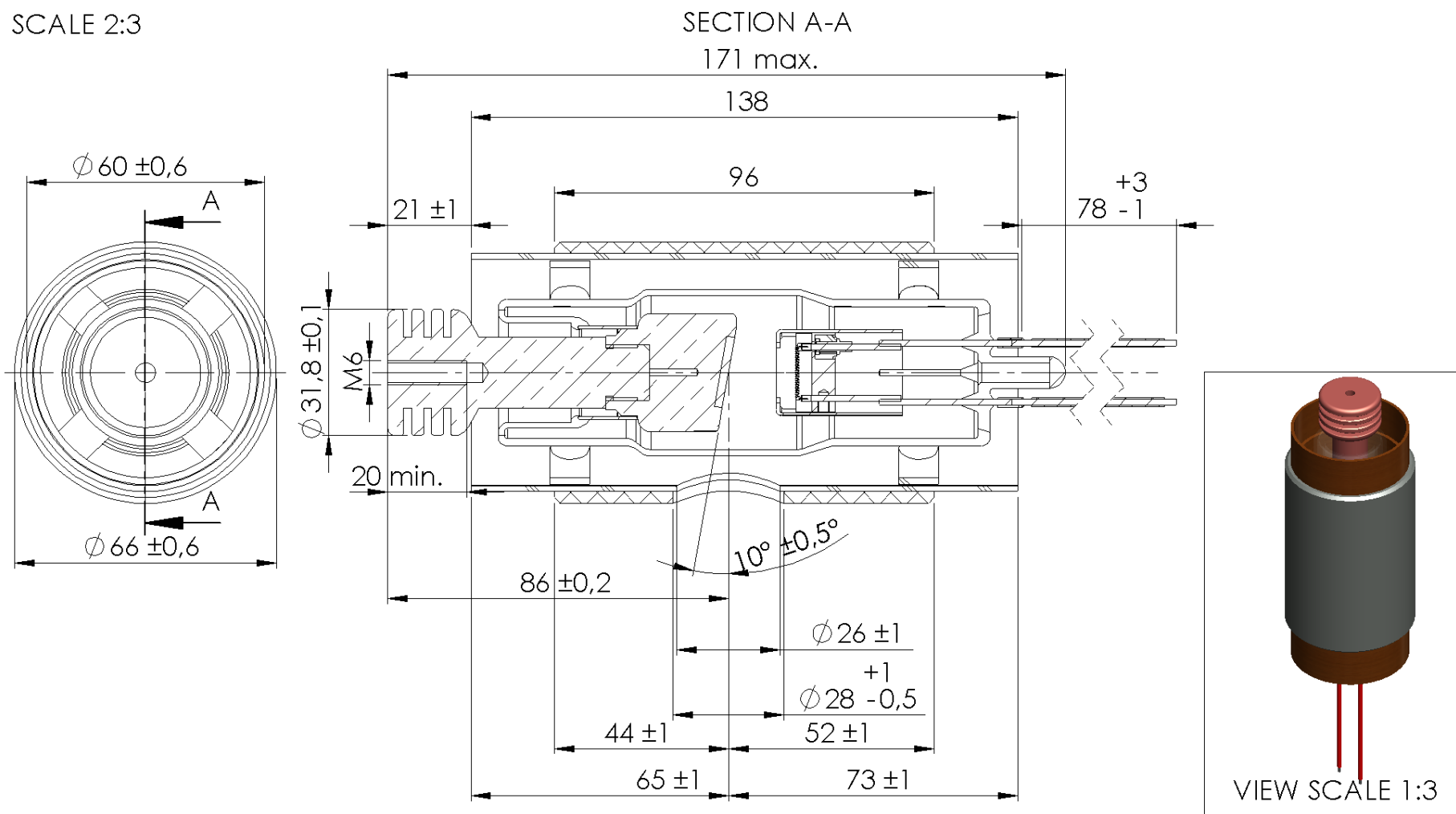



THERMAL CURVES

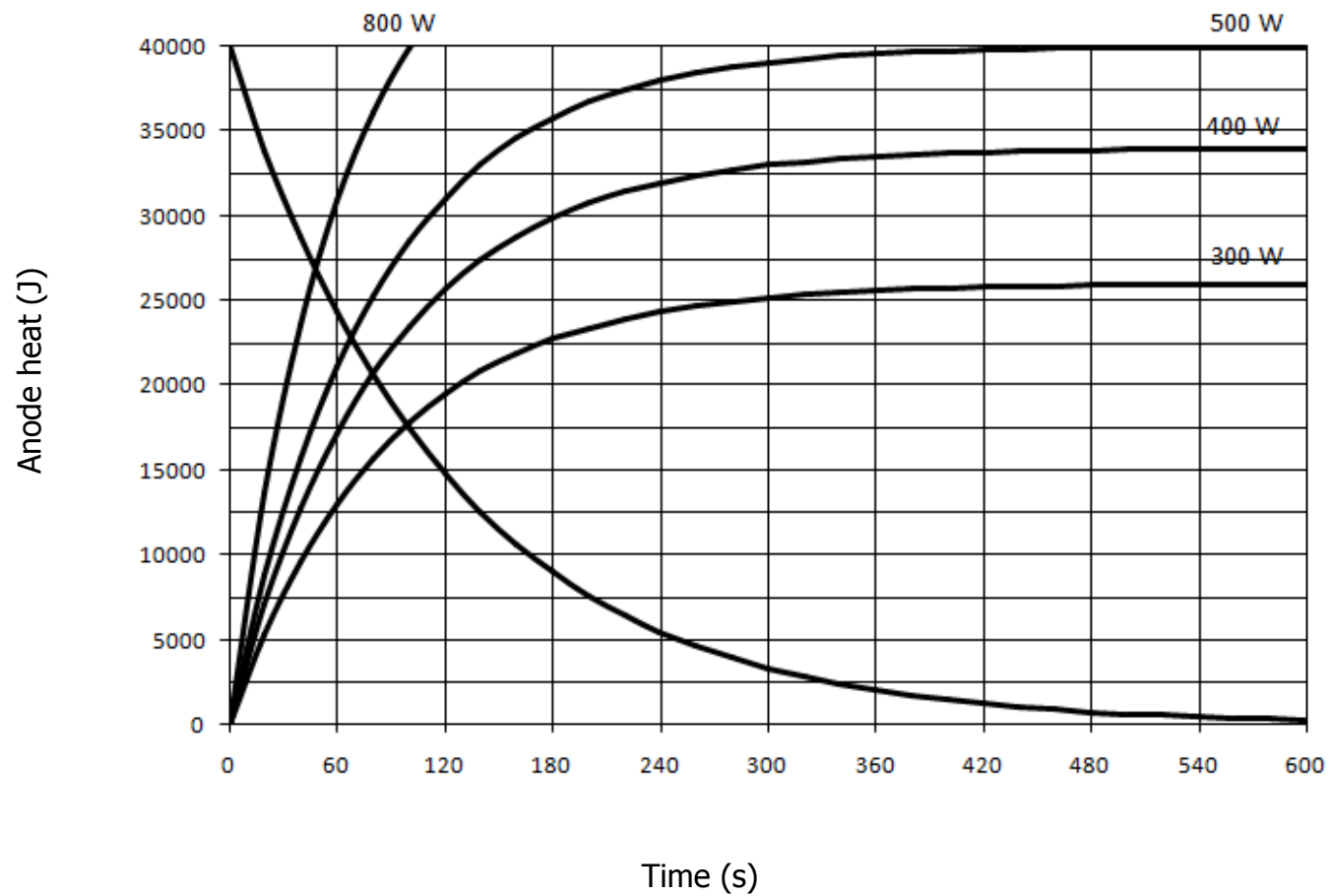



FILAMENT CHARACTERISTICS

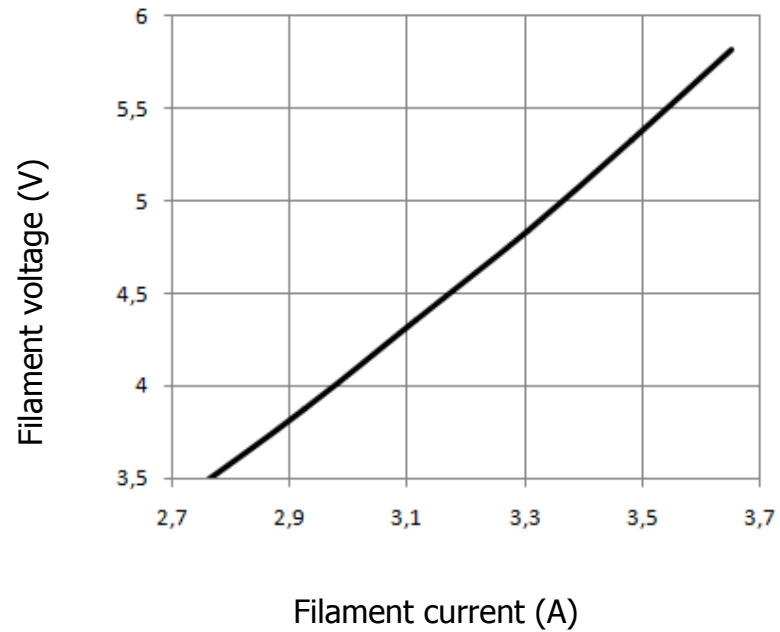

EMISSION CHARACTERISTICS DC

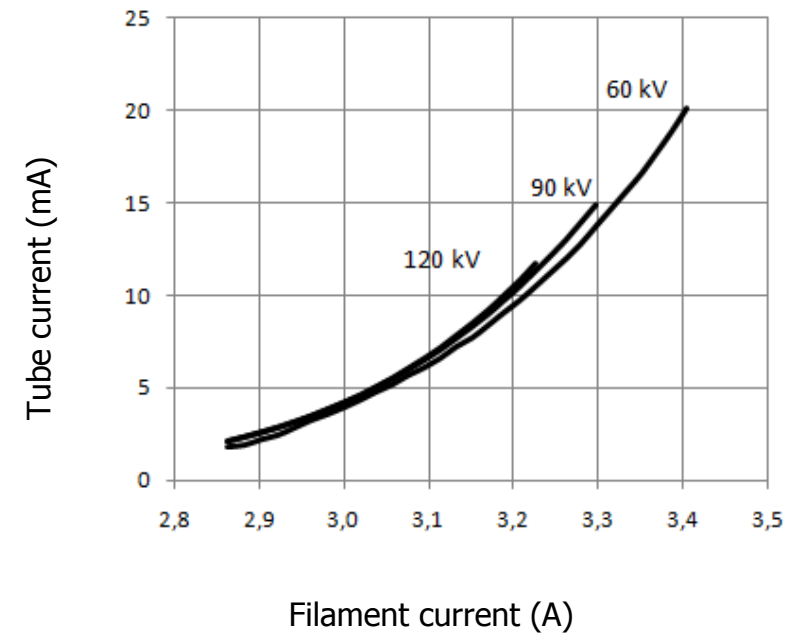



RATING CHARTS DC

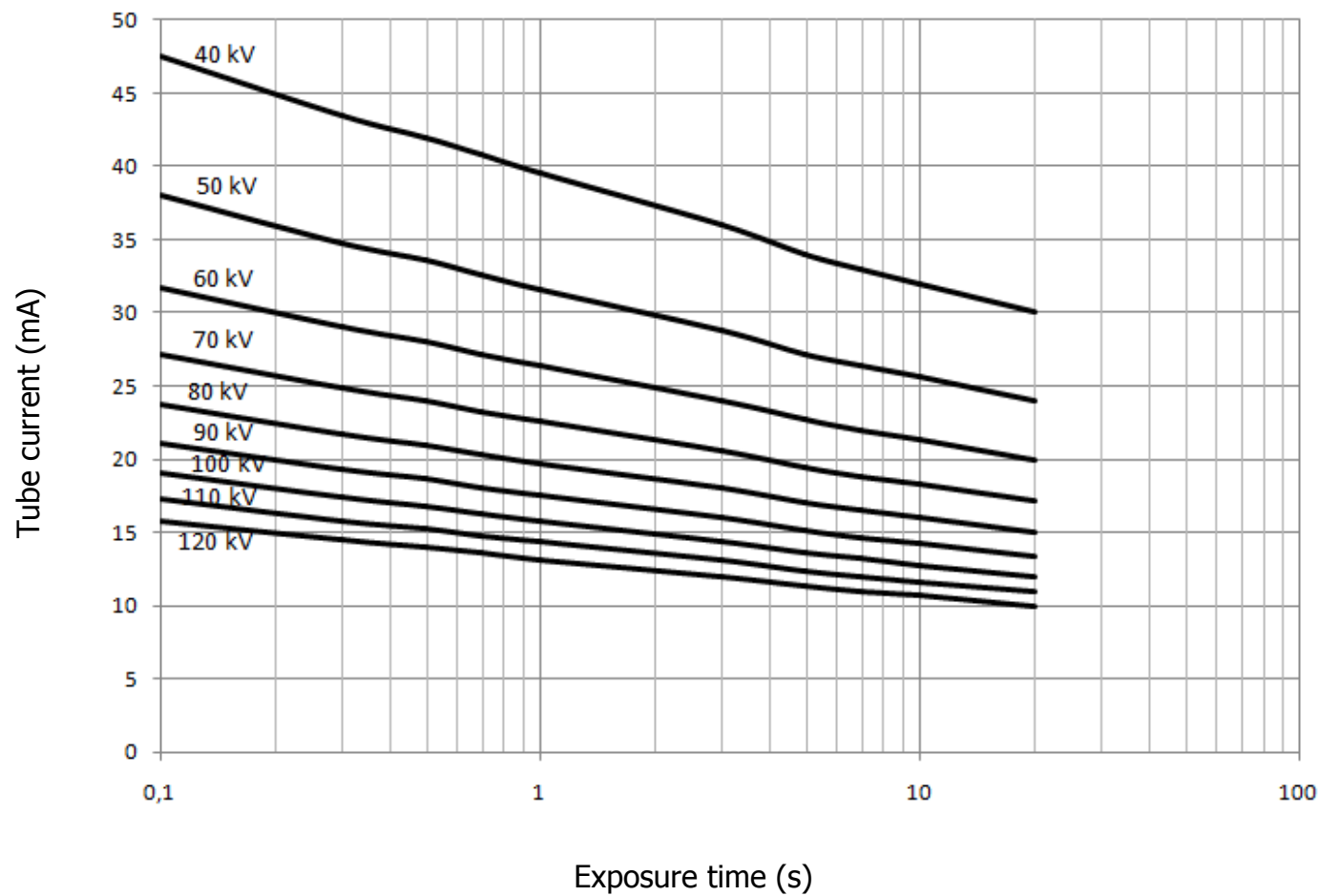

Note: This power rating has been verified in a large oil tank. Power rating may vary depending upon the oil capacity as well as the oil circulation in the testing tank.

**INFORMATION:**

Even if the tube is shipped after a long seasoning and testing cycle, it is always better to perform a quick seasoning before the first exposure. Please start the test cycle with the lowest kV possible in your machine, and increase the kV gradually with an incremental step of 5kV. For each step, perform at least 3 exposures maintaining the current parameter between 1mA and 2mA. A gap of few seconds between each of the exposures is advised. Increase the kV to the max kV as rated for the respective tube. In case of instability observed, reduce kV by one step. Once the kV reaches the nominal kV allowed for the respective tube, perform 3 exposures at the nominal power as requested for the concerned application.

Full seasoning is not required, when installing the machine. Nevertheless, if the tube head has been stored for more than 6 months, it is advised to perform few exposures at low kV and low power, before sending the machine to the final customer.